

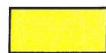

## T- Hangar Diagrams

### Northeast T-Hangars

-  = \$430.00
-  = \$490.00
-  = \$585.00

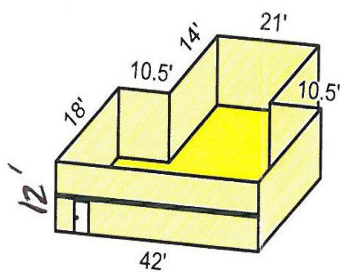

BAY 1 - 7

Approx. 1,050 sq. ft.

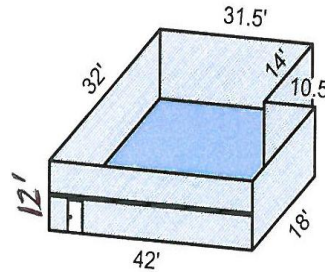

BAY 8

Approx. 1,197 sq. ft

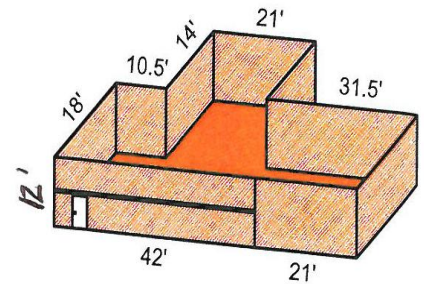

BAY 2X

Approx. 1,428 sq. ft.

*\*Prices will adjust May 1<sup>st</sup>.*

## T- Hangar Diagrams

### Southwest T-Hangars

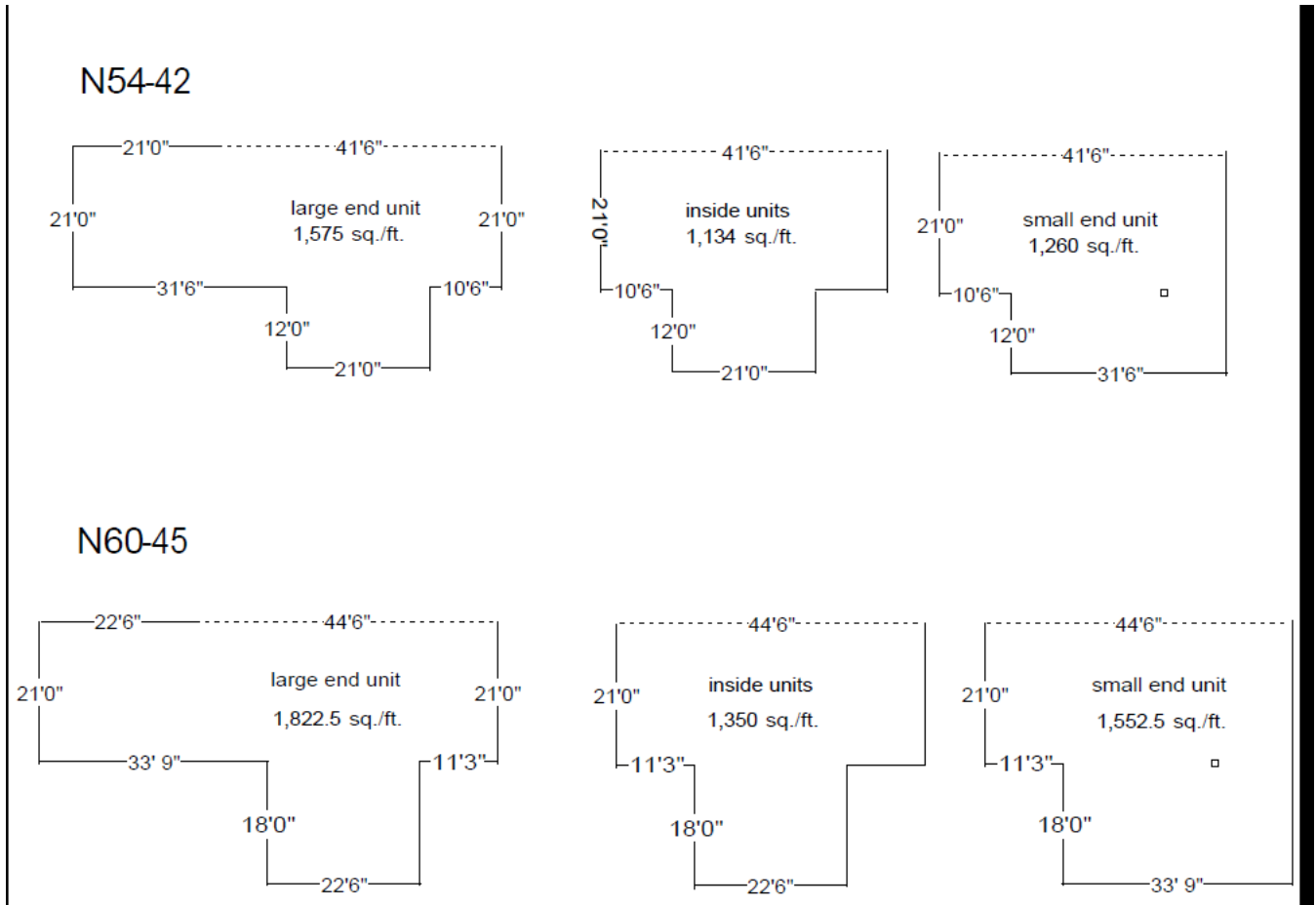

**N54-42**

- Large End Unit (50-2) = \$560.00**
- Inside Units (50-3 thru 50-10) = \$405.00**
- Small End Unit (50-1) = \$447.00**

**N60-45**

- Large End Unit (51-9) = \$645.00**
- Inside Units (51-1 thru 51-8) = \$480.00**
- Small End Unit (51-10) = \$551.00**

*\*Prices will adjust May 1<sup>st</sup>.*